

DATE PROJECT LOCATION TYPE



### PRODUCT FEATURES

- Line Voltage 100–120V – No Driver Required\*
- Quick Connection
- Innovative Slim Design
- Seamless and Diode Free
- Line Voltage Phase Dimming
- Product is approved for Closet/Storage space installation per NEC410.16 (A) (3) and NEC410.16 (C)(5) per NRTL certification
- Compatible with 3rd party dimmers
- Flicker Free
- Pendant Option Available
- Extrusion Available
- In-line On/Off Switch Available
- Flex Unit Available for Organic Shapes
- \*Also Available in 220–240V & 277V

### PRODUCT SPECIFICATIONS

- Voltage : AC 100–120V
- Operating Temperature : 0–45°C (32–113°F)
- Lamp Life : 50,000hr / 70%
- Available Color : 2700K, 3000K, 3500K, 4000K
- Color Rendering : CRI>90
- Beam Angle:130°
- 5 year warranty

### MAX. CONNECTION

- 400W in one row (single power feed)

### DIMENSIONS



Model Number	Voltage Input (V)	Lamp Power (W)	Lumens(lm) (CRI90)	A mm (inches)	B mm (inches)	C mm (inches)	D mm (inches)	E mm (inches)	F mm (inches)	G mm (inches)
NDF3-(Color)K-120V-C90	AC 100-120V	2.5	212	147 (5.8)	156 (6.1)	178.7 (7)	19 (0.75)	18 (0.71)	18 (0.71)	16.8 (0.66)
NDF5-(Color)K-120V-C90	AC 100-120V	5.34	340	282.5 (11.1)	291.5 (11.5)	314 (12.4)	19 (0.75)	18 (0.71)	18 (0.71)	16.8 (0.66)
NDF10-(Color)K-120V-C90	AC 100-120V	10.93	720	560.5 (22)	569.5 (22.4)	592 (23.3)	19 (0.75)	18 (0.71)	18 (0.71)	16.8 (0.66)
NDF15-(Color)K-120V-C90	AC 100-120V	16.08	1,080	839 (33)	848 (33.4)	870.5 (34.3)	19 (0.75)	18 (0.71)	18 (0.71)	16.8 (0.66)
NDF20-(Color)K-120V-C90	AC 100-120V	21.3	1,440	1,117 (43.4)	1,126 (44.3)	1,148.5 (45.2)	19 (0.75)	18 (0.71)	18 (0.71)	16.8 (0.66)
NDF3-(Color)K-120V-Flex2	AC 100-120V	5	413	147 (5.8)	156 (6.1)	360 (14.2)	19 (0.75)	18 (0.71)	18 (0.71)	16.8 (0.66)
NDF3-(Color)K-120V-Flex3	AC 100-120V	6.93	657	147 (5.8)	156 (6.1)	527 (20.7)	19 (0.75)	18 (0.71)	18 (0.71)	16.8 (0.66)
NDF3-(Color)K-120V-Flex5	AC 100-120V	9.12	1,013	147 (5.8)	156 (6.1)	841 (33.1)	19 (0.75)	18 (0.71)	18 (0.71)	16.8 (0.66)

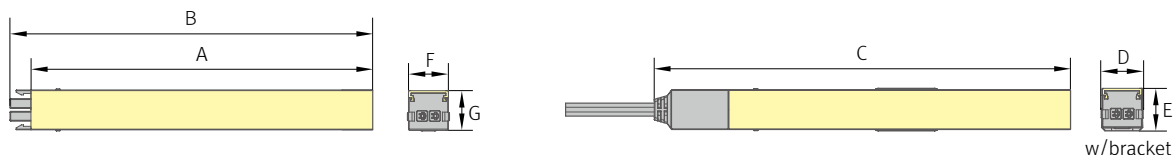

**\* Flexible Connector**

NDF3 40K-120V-C90-Flex2

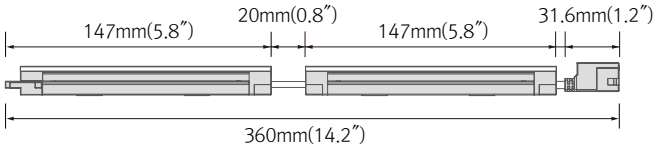

NDF3 40K-120V-C90-Flex3

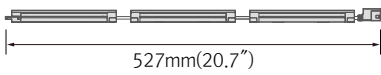

NDF3 40K-120V-C90-Flex5

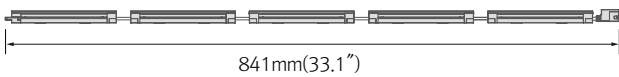

**\* LED 90° Connector**

NDF3 40K-120V-C90-90

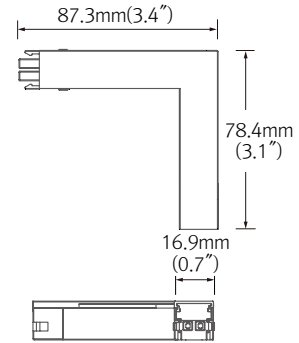

**\* LED Power Cord**

NDF3 40K-120V-C90-PC / OPC

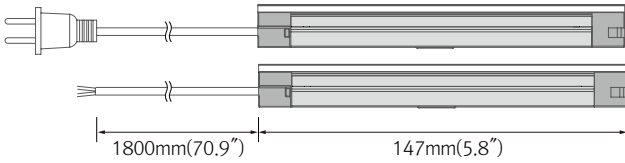

**\* NDF ON/OFF Switch**

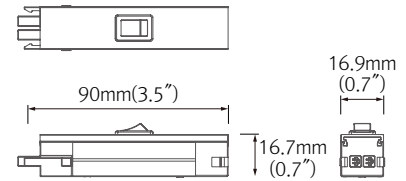

**\* NDF Extrusion Line**

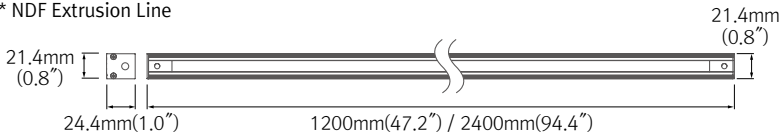

**\* 90 degree connector for NDF-EXL**

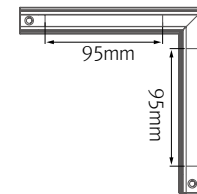

**\* NDF PENDANT**

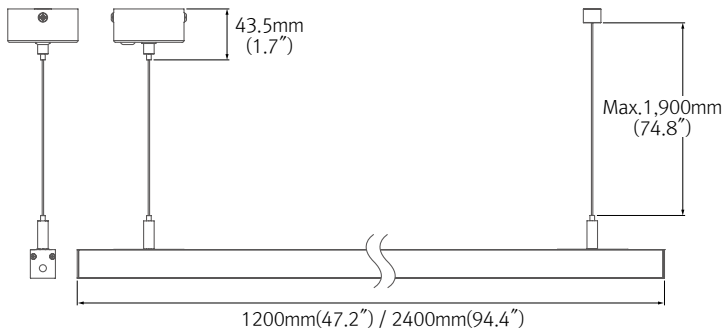

**EASY CONNECTION**

**VARIOUS OPTIONS**

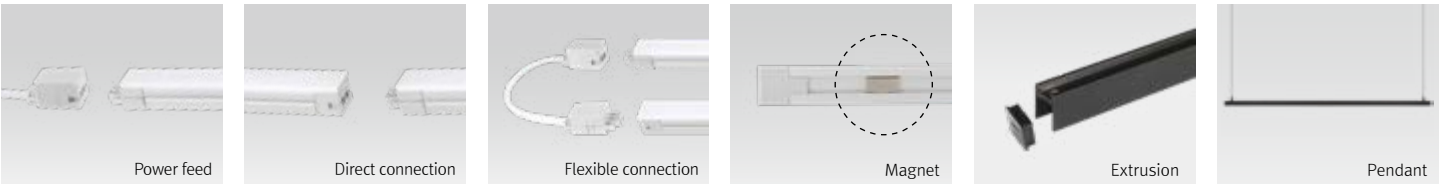

**BEAM SPREADS**

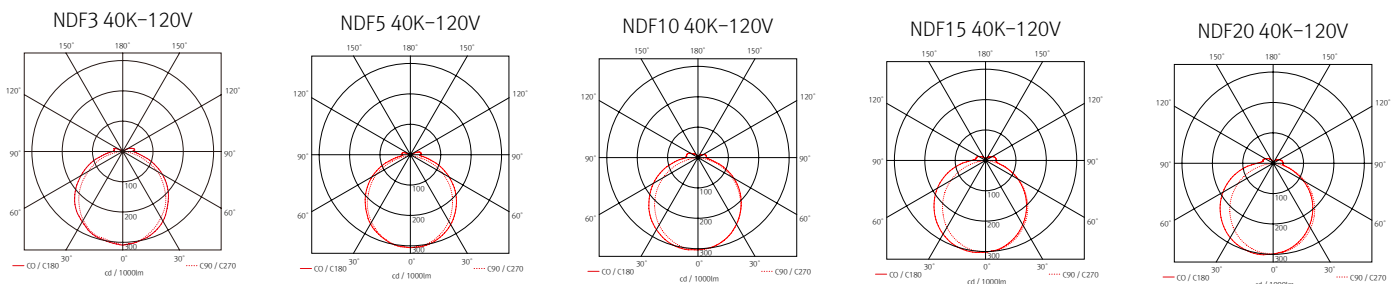

## INSTALLATION

### ☆Before Installation(Power Connection)

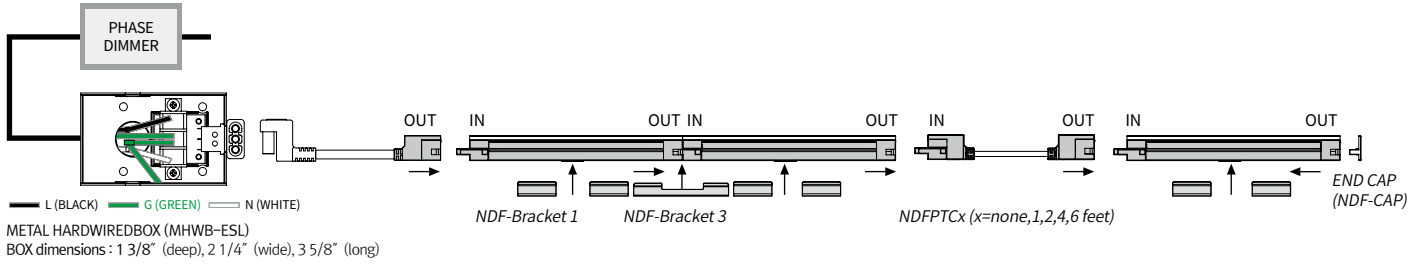

### ☆After Installation

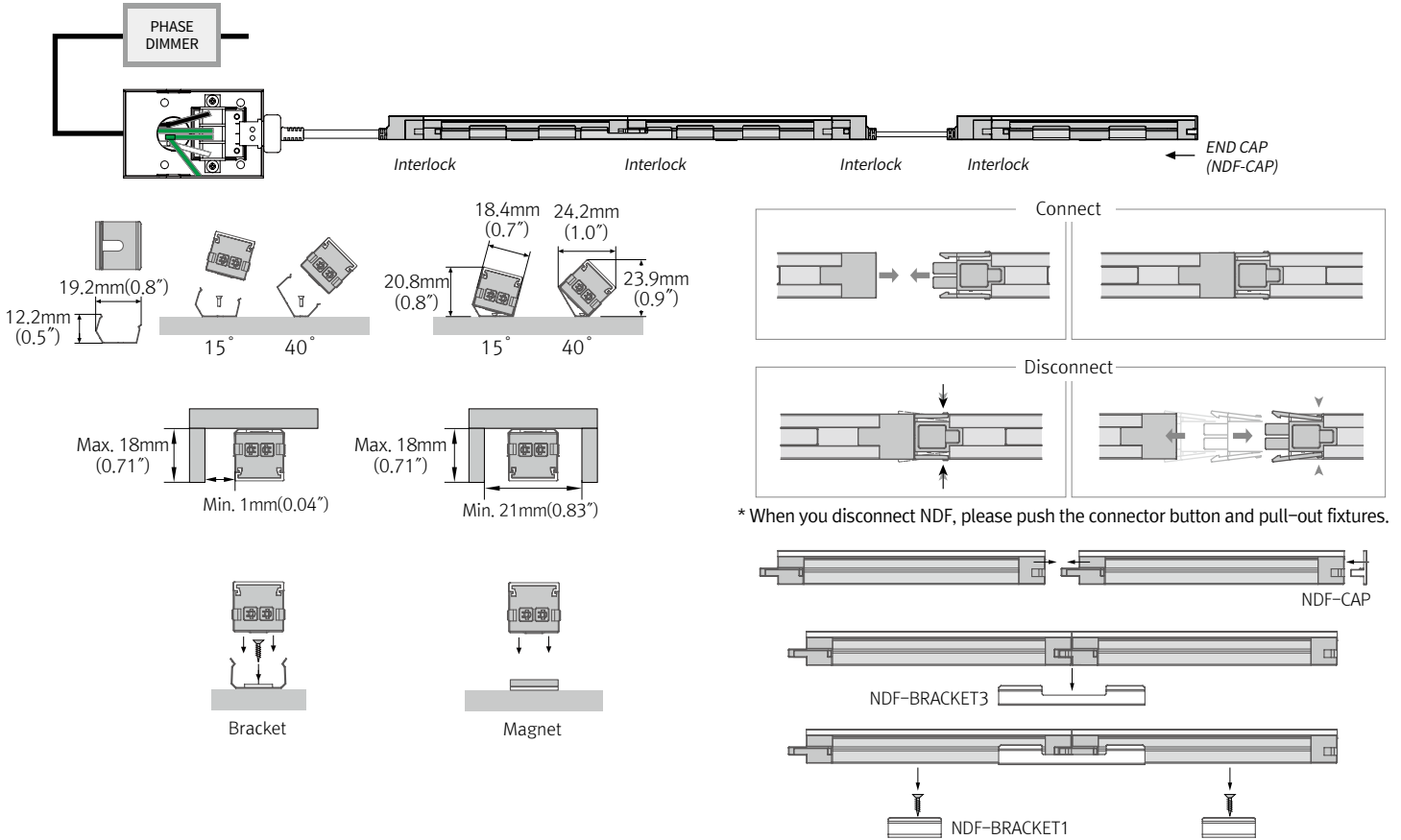

### ☆Pendant Installation

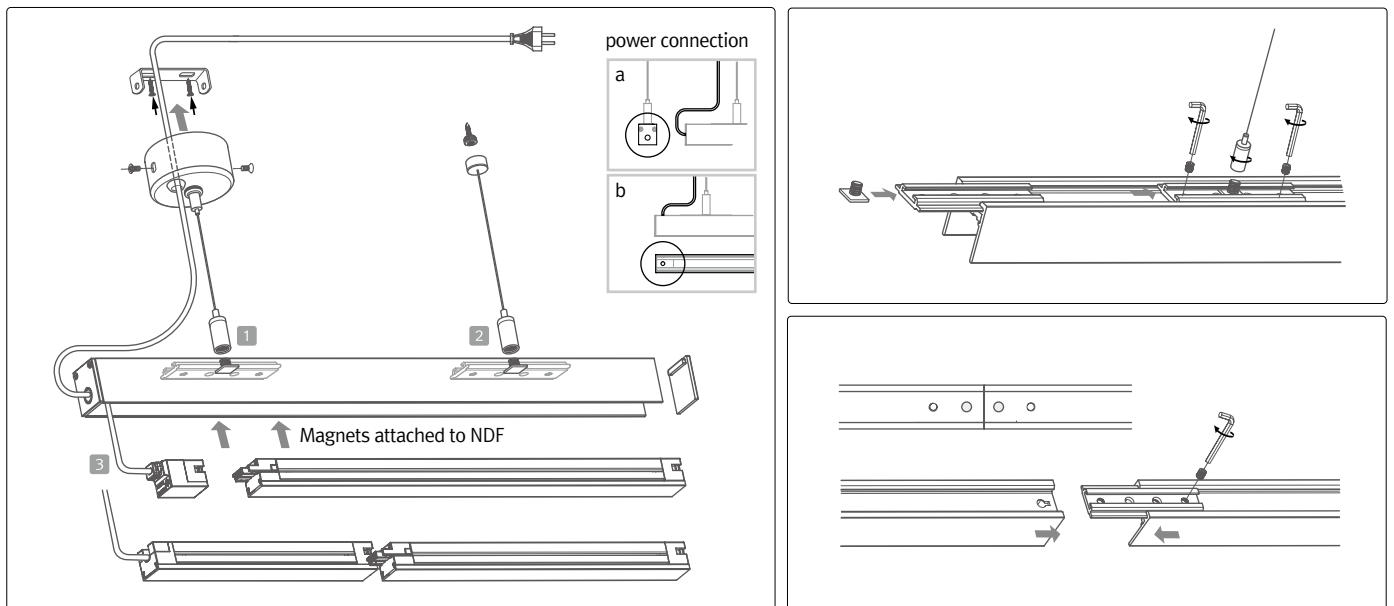

## COMPONENTS

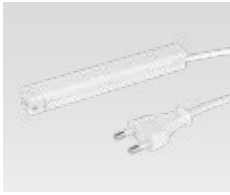

**LED Power connector**  
 \_\_NDF3-(Color)K-120V-PC  
 NDF3 (5.8") fixture with  
 6' power cord



**Connecting Cable**  
 \_\_NDFPTC/XL (6")  
 \_\_NDFPTC1/XL (1')  
 \_\_NDFPTC2/XL (2')  
 \_\_NDFPTC4/XL (4')  
 \_\_NDFPTC6/XL (6')



**Suspension bracket**  
 \_\_NDF-SK-BRACKET  
 Suspension Bracket for NDF

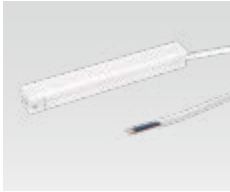

**LED open power connector**  
 \_\_NDF3-(Color)K-120V-OPC  
 NDF3 (5.8") fixture with  
 6' open power cord



**Hard wire box Cable**  
 \_\_ESLNDNFPTC/XL (6")  
 \_\_ESLNDNFPTC1/XL (1')  
 \_\_ESLNDNFPTC2/XL (2')  
 \_\_ESLNDNFPTC4/XL (4')  
 \_\_ESLNDNFPTC6/XL (6')  
 Interface cable between NDF  
 & Hard wire box



**Suspension Power Kit**  
 \_\_NDF-SK-POWER  
 Suspension Power Kit  
 for NDF



**LED 90° Connector**  
 \_\_NDF3-(Color)K-120V-90

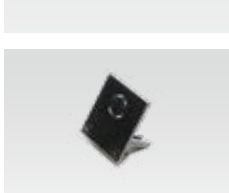

**Extrusion End Cap**  
 \_\_NDF-EXL-CAP  
 Included with Track



**Extrusion Joint Bracket**  
 \_\_NDF-JOINT BRACKET



**Flexible Connector**  
 \_\_NDF3-(Color)K-120V-Flex2  
 (14.15")  
 \_\_NDF3-(Color)K-120V-Flex3  
 (20.53")  
 \_\_NDF3-(Color)K-120V-Flex5  
 (32.")



**NDF Extrusion line**  
 \_\_NDF-EXL (1.2m)  
 \_\_NDF-EXL (2.4m)



**Dimming Interface (Dail)**  
 \_\_FDS-H1DA-SR  
 Max. 200W (200W/CH,1CH)



**On/Off Switch**  
 \_\_NDF-SW



**90 degree connector for NDF-EXL**  
 \_\_NDF-EXL-90



**Dimming Interface (Bluetooth)**  
 \_\_FDS-H1B-SR  
 Max. 200W (100W/CH,1CH)



**Hard Wire Box**  
 \_\_MHWB-ESL



**Mounting Bracket**  
 \_\_NDF-BRACKET1  
 Included with fixture



**Dimming Interface (Dail)**  
 \_\_FDS-H2DA-SR  
 Max. 288W (144W/CH,2CH)



**Power Cord**  
 \_\_NDFPC/XL (6')



**Angle bracket**  
 \_\_NDF-BRACKET2

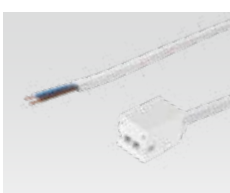

**Open Power Cord**  
 \_\_NDFOPC/XL (6')



**Connecting bracket**  
 \_\_NDF-BRACKET3  
 Included with fixture