

DATE	PROJECT	LOCATION	TYPE
------	---------	----------	------



## PRODUCT FEATURES

- Use constant voltage DC 24V driver
- Mini pole spotlight with Beam options 28°, 40° & 50° degree
- Effective focusing ability for showcases
- Dim 0–10V
- Available in black, white (Special order option: gold, silver)
- Link up to 10 units together

## PRODUCT SPECIFICATIONS

- Voltage : DC 24V
- Operating Temperature : 0–45°C (32–113°F)
- Lamp Life : 50,000hr / 70%
- Available CCTs : 2700K, 3000K, 3500K, 4000K
- Color Rendering : CRI>90
- Finishes : Black, White (Special Order Option–Gold, Silver)
- Dimmable
- 5 year warranty

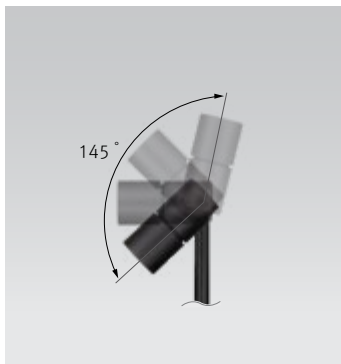

## SPECIFICATION

\*Based on 4000K

Model Name	Power Input	Lamp Power	Luminous Flux	Luminous Efficacy	Color Rendering Index	Color Temperature	Beam Angle	Finish	Plate
DVP3 (Color)K-24V-POLE -BK-28-RP	DC 24V	2.6 W	279.2 lm	105.8 lm/W	CRI > 90	2700K/3000K 3500K/4000K	28° 40° 50°	BK,WT (Special Order Option - GD,SV)	Round/ Square

## SPECIFICATION GUIDE

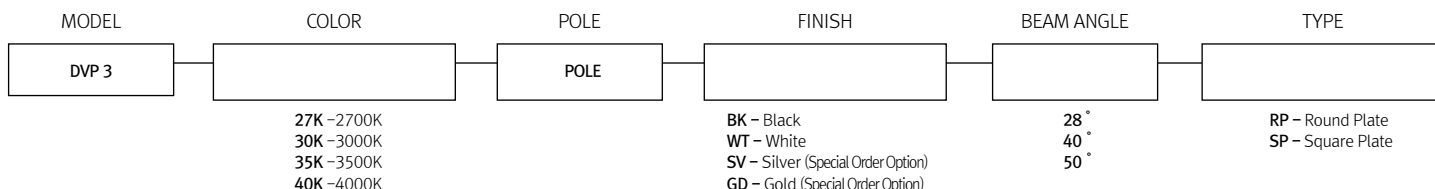

## DIMENSION

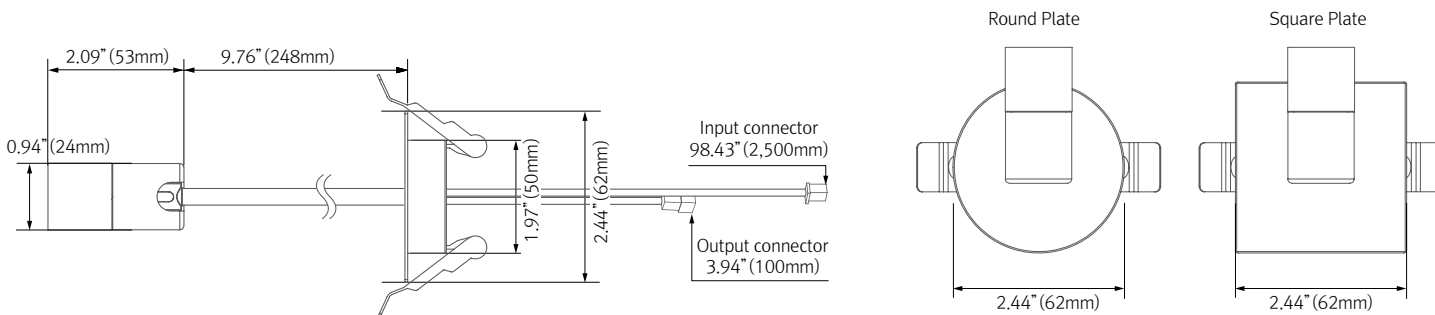

## INSTALLATION

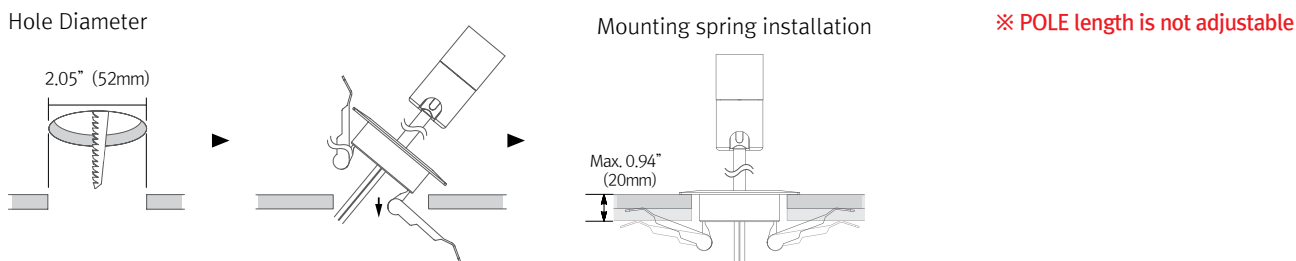

★ Linkable between FLX Spot DVP (POLE) and FLX Spot DVP(POLE) (Max. 10 units connectable)

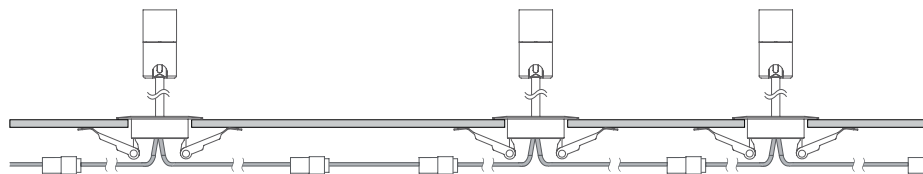

## BEAM ANGLE

DVP3 40K-24V-POLE-BK-28-RP

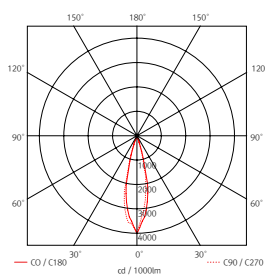

DVP3 40K-24V-POLE-BK-40-RP

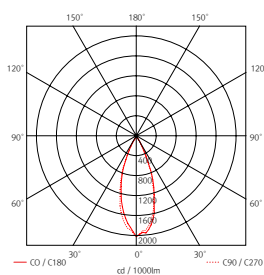

DVP3 40K-24V-POLE-BK-50-RP

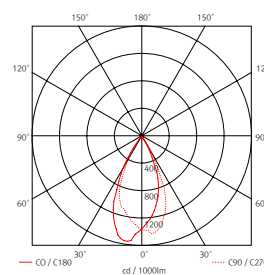

## COMPONENTS



**FLX Spot DVP POLE**  
 \_\_DVP3 (Color)K-24V-  
 POLE-BK-28-RP



**FLX Spot DVP POLE**  
 \_\_DVP3 (Color)K-24V-  
 POLE-BK-28-SP



**DVP-HOOD**  
 \_\_DVP3-HOOD-BK-28 (28°)  
 \_\_DVP3-HOOD-BK-40 (40°)  
 \_\_DVP3-HOOD-BK-50 (50°)  
 Hood with lens for various  
 beam angle replacement



**Dimming Interface  
 (0-10V)**  
 \_\_FDC-L10  
 Max. 100W (100W/CH, 1CH)  
 0-10V Signal



**Dimming Interface  
 (DMX512)**  
 \_\_FDA-L2MO  
 Max. 200W (100W/CH, 2CH)  
 \_\_FDA-L5M  
 Max. 200W (50W/CH, 5CH)



**Dimming Interface  
 (DALI)**  
 \_\_FDD-L1DA



**Dimming Interface  
 (Zigbee)\_FDD-L2Z**  
 \_\_FDD-L2Z



**Wireless Control  
 (Zigbee Switch)**  
 \_\_FSM-Z1



**12 Port Hub**  
 \_\_D12P-HUB  
 Included with Cord and Plug  
 drivers. Order separately for  
 Hard Wire or 3rd Party Drivers



**Driver Junction Box**  
 \_\_MHWB-FLE



**LED Drivers**  
 \_\_FLC30-24V/XL\*  
 \_\_FLC75-24V/XL\*  
 with distributor and power  
 cord (70" (1,800mm))



**Hard Wire Driver**  
 \_\_XLD200-224V-FCL-DIM  
 \_\_XLD75-124V-FC  
 (90V to 300V)



**Hard Wire Driver**  
 \_\_FLE90-24V-L10-DIM  
**Additional Power Supply/  
 Driver Options Available.**  
**Please consult Factory.**