

DATE	PROJECT	LOCATION	TYPE
------	---------	----------	------



### PRODUCT FEATURES

- Line Voltage 277V – No Driver Required\*
- Quick Connection
- Innovative Slim Design
- Seamless and Diode Free
- Line Voltage Phase Dimming
- Product is approved for Closet/Storage space installation per NEC410.16 (A) (3) and NEC410.16 (C)(5) per NRTL certification
- Compatible with 3rd party dimmers
- Flicker Free
- Pendant Option Available
- Extrusion Available
- In-line On/Off Switch Available
- Flex Unit Available for Organic Shapes
- ELV Dim

### PRODUCT SPECIFICATIONS

- Voltage : AC 277V
- Operating Temperature : 0-45°C (32-113°F)
- Lamp Life : 50,000hr / 70%
- Available Color : 2700K, 3000K, 3500K, 4000K
- Color Rendering : CRI>90
- Beam Angle:130°
- 5 year warranty

### MAX. CONNECTION

- 400W in one row (single power feed)

### DIMENSIONS



Model Number	Voltage Input (V)	Lamp Power (W)	Lumens(lm) (CRI90)	A mm (inches)	B mm (inches)	C mm (inches)	D mm (inches)	E mm (inches)	F mm (inches)	G mm (inches)
NDF3-(Color)K-277V-C90	AC 277V	2.5	212	147 (5.8)	156 (6.1)	178.7 (7)	19 (0.75)	18 (0.71)	18 (0.71)	16.8 (0.66)
NDF5-(Color)K-277V-C90	AC 277V	5.34	340	282.5 (11.1)	291.5 (11.5)	314 (12.4)	19 (0.75)	18 (0.71)	18 (0.71)	16.8 (0.66)
NDF10-(Color)K-277V-C90	AC 277V	10.93	720	560.5 (22)	569.5 (22.4)	592 (23.3)	19 (0.75)	18 (0.71)	18 (0.71)	16.8 (0.66)
NDF15-(Color)K-277V-C90	AC 277V	16.08	1,080	839 (33)	848 (33.4)	870.5 (34.3)	19 (0.75)	18 (0.71)	18 (0.71)	16.8 (0.66)
NDF20-(Color)K-277V-C90	AC 277V	21.3	1,440	1,117 (43.4)	1,126 (44.3)	1,148.5 (45.2)	19 (0.75)	18 (0.71)	18 (0.71)	16.8 (0.66)
NDF3-(Color)K-277V-Flex2	AC 277V	5	413	147 (5.8)	156 (6.1)	360 (14.2)	19 (0.75)	18 (0.71)	18 (0.71)	16.8 (0.66)
NDF3-(Color)K-277V-Flex3	AC 277V	6.93	657	147 (5.8)	156 (6.1)	527 (20.7)	19 (0.75)	18 (0.71)	18 (0.71)	16.8 (0.66)
NDF3-(Color)K-277V-Flex5	AC 277V	9.12	1,013	147 (5.8)	156 (6.1)	841 (33.1)	19 (0.75)	18 (0.71)	18 (0.71)	16.8 (0.66)

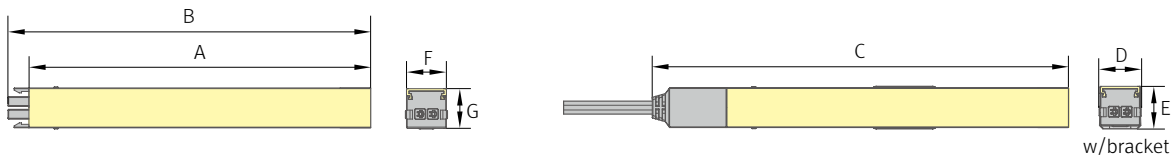

**\* Flexible Connector**

NDF3 40K-277V-C90-Flex2

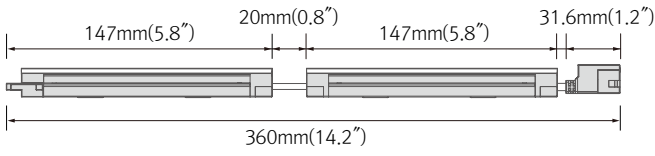

NDF3 40K-277V-C90-Flex3

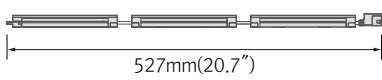

NDF3 40K-277V-C90-Flex5

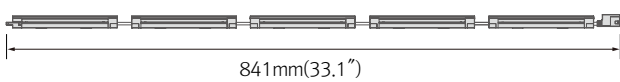

**\* LED 90° Connector**

NDF3 40K-277V-C90-90

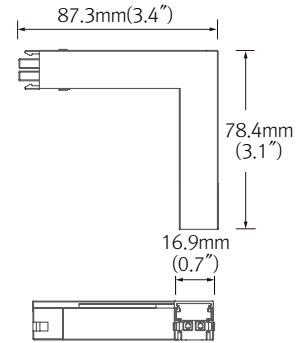

**\* LED Power Cord**

NDF3 40K-277V-C90-OPC

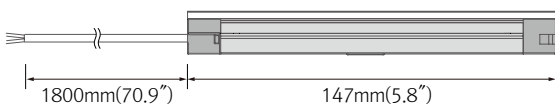

**\* NDF ON/OFF Switch**

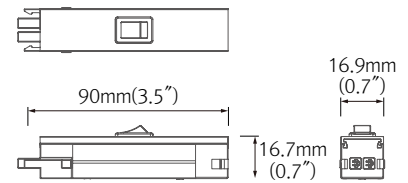

**\* NDF Extrusion Line**

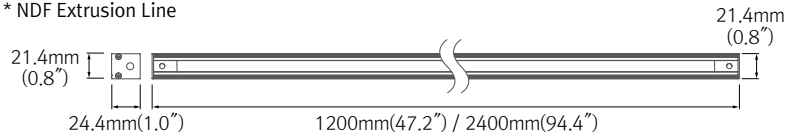

**\* 90 degree connector for NDF-EXL**

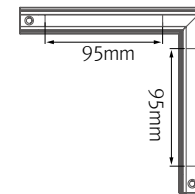

**\* NDF PENDANT**

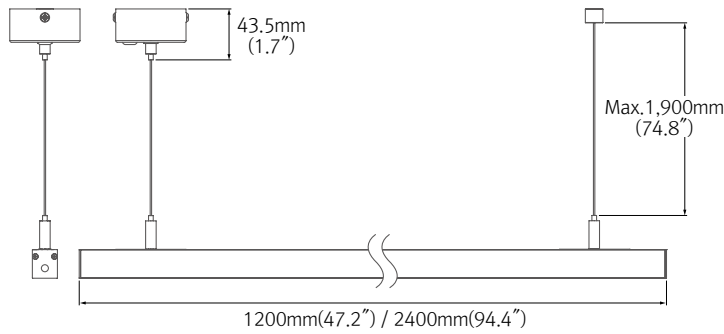

**EASY CONNECTION**

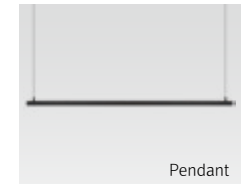
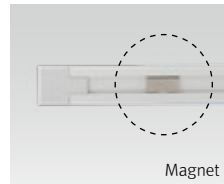
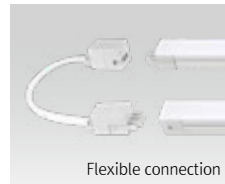
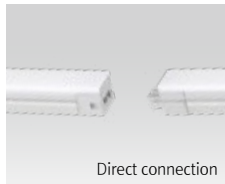
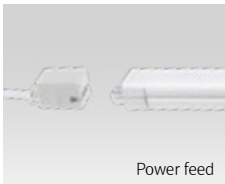

**VARIOUS OPTIONS**

**BEAM SPREADS**

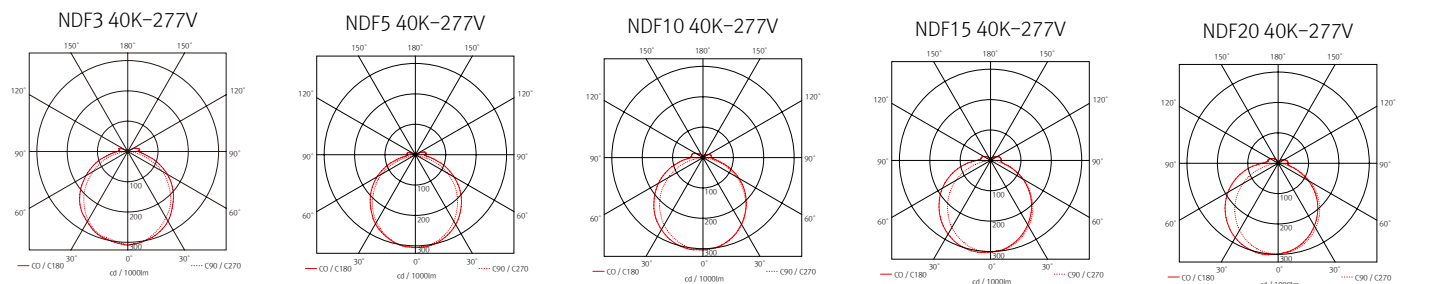

## INSTALLATION

### ☆Before Installation(Power Connection)

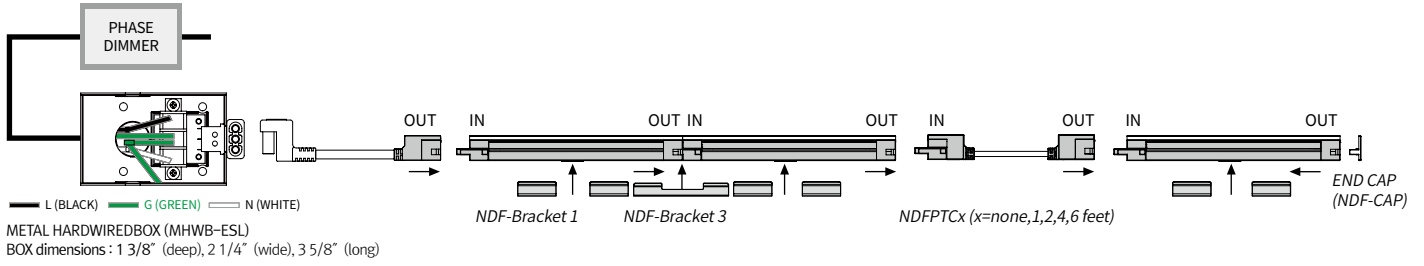

### ☆After Installation

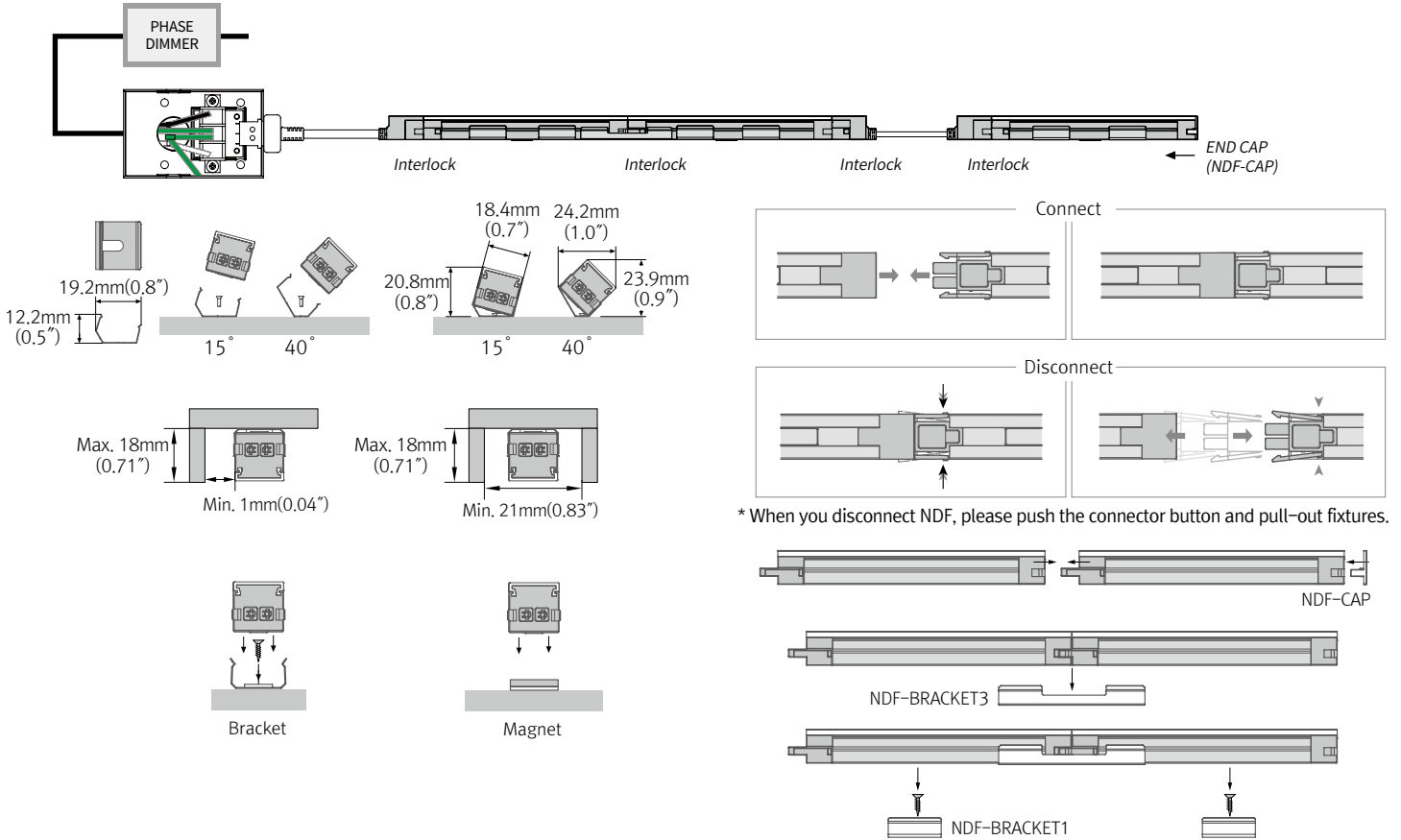

### ☆Pendant Installation

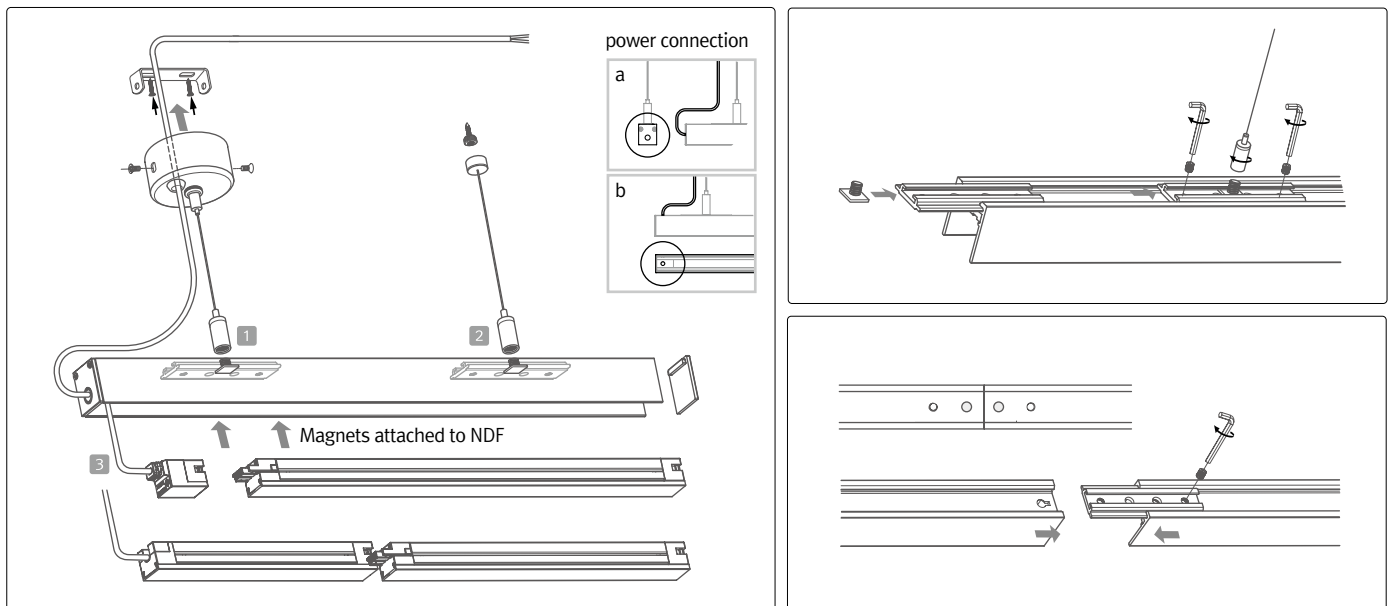

## COMPONENTS

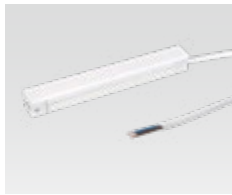

**LED open power connector**  
 \_\_NDF3-(Color)K-277V-OPC  
 NDF3 (5.8") fixture with  
 6' open power cord



**Connecting Cable**  
 \_\_NDFPTC/XL (6")  
 \_\_NDFPTC1/XL (1')  
 \_\_NDFPTC2/XL (2')  
 \_\_NDFPTC4/XL (4')  
 \_\_NDFPTC6/XL (6')



**Suspension bracket**  
 \_\_NDF-SK-BRACKET  
 Suspension Bracket for NDF



**LED 90° Connector**  
 \_\_NDF3-(Color)K-277V-90



**Hard wire box Cable**  
 \_\_ESLNDFPTC/XL (6")  
 \_\_ESLNDFPTC1/XL (1')  
 \_\_ESLNDFPTC2/XL (2')  
 \_\_ESLNDFPTC4/XL (4')  
 \_\_ESLNDFPTC6/XL (6')  
 Interface cable between NDF  
 & Hard wire box



**Suspension Power Kit**  
 \_\_NDF-SK-POWER  
 Suspension Power Kit  
 for NDF



**Flexible Connector**  
 \_\_NDF3-(Color)K-277V-Flex2  
 (14.15")  
 \_\_NDF3-(Color)K-277V-Flex3  
 (20.53")  
 \_\_NDF3-(Color)K-277V-Flex5  
 (32")

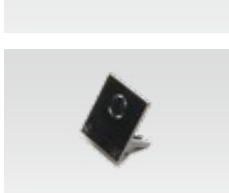

**Extrusion End Cap**  
 \_\_NDF-EXL-CAP  
 Included with Track



**Extrusion Joint Bracket**  
 \_\_NDF-JOINT BRACKET



**On/Off Switch**  
 \_\_NDF-SW



**NDF Extrusion line**  
 \_\_NDF-EXL (1.2m)  
 \_\_NDF-EXL (2.4m)



**Dimming Interface  
 (Dail)**  
 \_\_FDS-H1DA-SR  
 Max. 200W (200W/CH,1CH)



**Hard Wire Box**  
 \_\_MHWB-ESL



**90 degree connector for  
 NDF-EXL**  
 \_\_NDF-EXL-90



**Dimming Interface  
 (Bluetooth)**  
 \_\_FDS-H1B-SR  
 Max. 200W (100W/CH,1CH)



**Open Power Cord**  
 \_\_NDFOPC/XL (6')



**Mounting Bracket**  
 \_\_NDF-BRACKET1  
 Included with fixture



**Dimming Interface  
 (Dail)**  
 \_\_FDS-H2DA-SR  
 Max. 288W (144W/CH,2CH)



**Angle bracket**  
 \_\_NDF-BRACKET2



**Connecting bracket**  
 \_\_NDF-BRACKET3  
 Included with fixture