

DATE	PROJECT	LOCATION	TYPE
------	---------	----------	------



PRODUCT FEATURES

- Line Voltage 220–240V – No Driver Required
- Quick Connection
- Innovative Slim Design
- Seamless and Diode Free
- Line Voltage Phase Dimming
- Product is approved for Closet/Storage space installation per NEC410.16 (A) (3) and NEC410.16 (C)(5) per NRTL certification
- Dimmable with 3rd party dimmer
- Flicker Free
- Pendant Option Available
- Extrusion Available
- In-line On/Off Switch Available
- Flex Unit Available for Organic Shapes

PRODUCT SPECIFICATIONS

- Voltage : AC 220–240V
- Operating Temperature : 32–113° F (0–45° C)
- Lamp Life : 55,000hr / 70%
- Available Color : 2700K, 3000K, 3500K, 4000K
- Color Rendering : CRI>90
- 5 year warranty

MAX. CONNECTION

- 400W in one row (single power feed)

DIMENSIONS



Model Number	Voltage Input (V)	Lamp Power (W)	Lumens(lm) (CRI90)	A inches (mm)	B inches (mm)	C inches (mm)	D inches (mm)	E inches (mm)	F inches (mm)	G inches (mm)
NDF3-(Color)K-230V-C90	AC 220-240V	2.5	212	147 (5.8)	156 (6.1)	178.7 (7)	19 (0.75)	18 (0.71)	18 (0.71)	16.8 (0.66)
NDF5-(Color)K-230V-C90	AC 220-240V	5.34	340	282.5 (11.1)	291.5 (11.5)	314 (12.4)	19 (0.75)	18 (0.71)	18 (0.71)	16.8 (0.66)
NDF10-(Color)K-230V-C90	AC 220-240V	10.93	720	560.5 (22)	569.5 (22.4)	592 (23.3)	19 (0.75)	18 (0.71)	18 (0.71)	16.8 (0.66)
NDF15-(Color)K-230V-C90	AC 220-240V	16.08	1,080	839 (33)	848 (33.4)	870.5 (34.3)	19 (0.75)	18 (0.71)	18 (0.71)	16.8 (0.66)
NDF20-(Color)K-230V-C90	AC 220-240V	21.3	1,440	1,117 (43.4)	1,126 (44.3)	1,148.5 (45.2)	19 (0.75)	18 (0.71)	18 (0.71)	16.8 (0.66)
NDF3-(Color)K-120V-Flex2	AC 220-240V	5	413	147 (5.8)	156 (6.1)	360 (14.2)	19 (0.75)	18 (0.71)	18 (0.71)	359.4 (14.15)
NDF3-(Color)K-230V-Flex3	AC 220-240V	6.93	657	147 (5.8)	156 (6.1)	178.7 (7)	19 (0.75)	18 (0.71)	18 (0.71)	521.4 (20.53)
NDF3-(Color)K-230V-Flex5	AC 220-240V	9.12	1,013	147 (5.8)	156 (6.1)	178.7 (7)	19 (0.75)	18 (0.71)	18 (0.71)	812.8 (32)

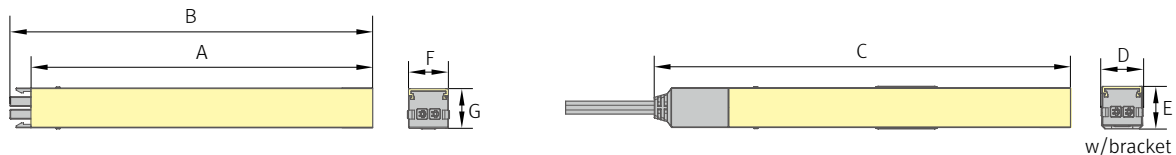

*** Flexible Connector**

NDF3 40K-230V-C90-Flex2

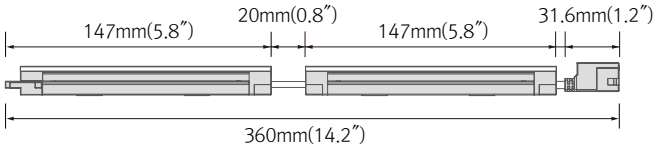

NDF3 40K-230V-C90-Flex3

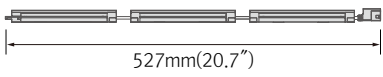

NDF3 40K-230V-C90-Flex5

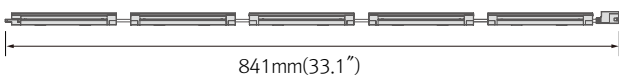

*** LED 90° Connector**

NDF3 40K-230V-C90-90

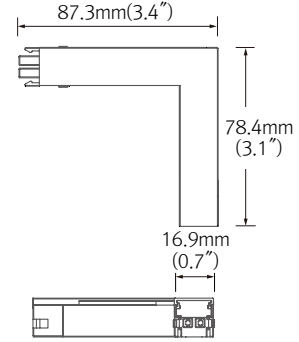

*** LED Power Cord**

NDF3 40K-230V-C90-PC / OPC

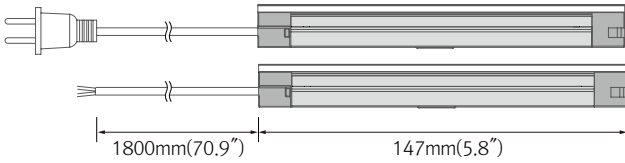

*** NDF ON/OFF Switch**

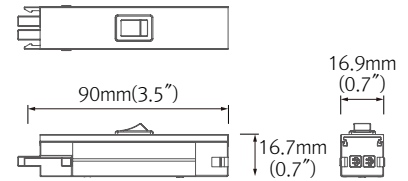

*** NDF Extrusion Line**

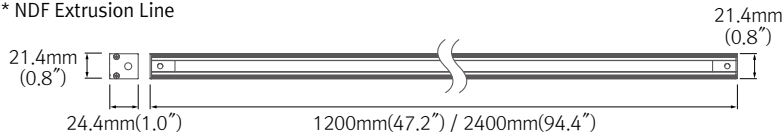

*** 90 degree connector for NDF-EXL**

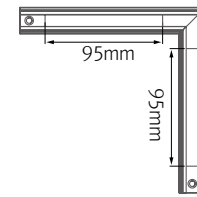

*** NDF PENDANT**

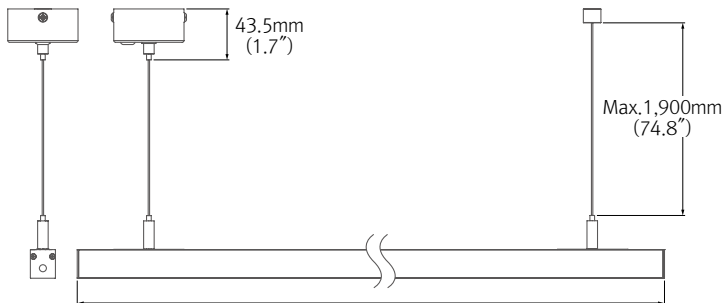

EASY CONNECTION

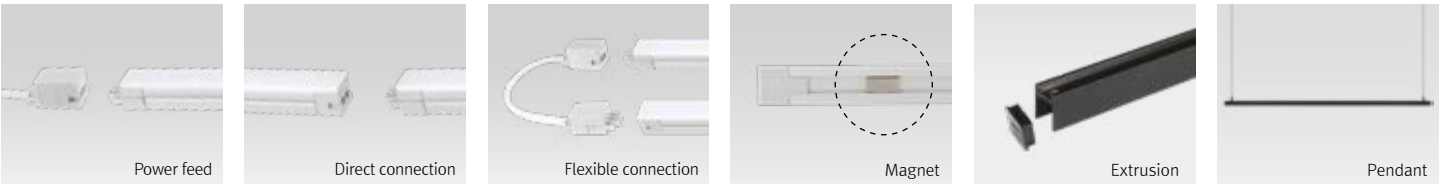

VARIOUS OPTIONS

BEAM SPREADS

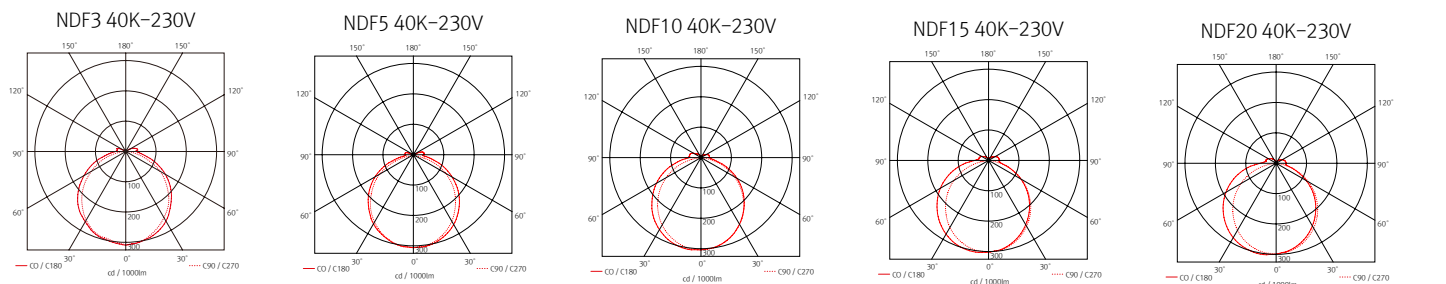

INSTALLATION

☆Before Installation(Power Connection)

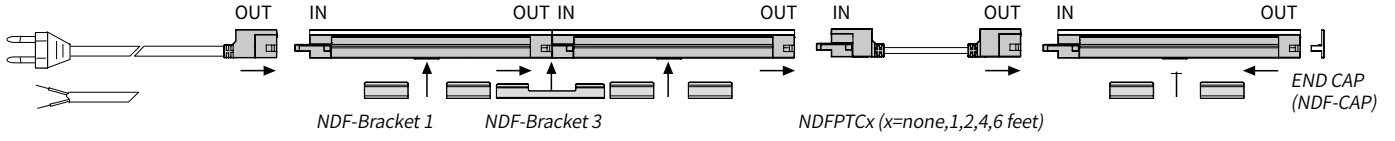

☆After Installation

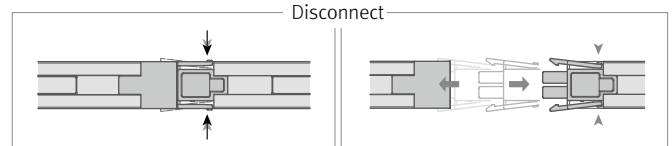
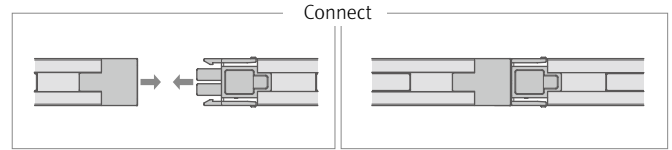
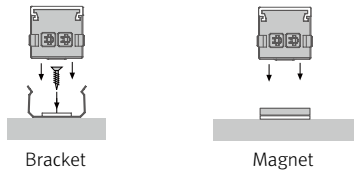
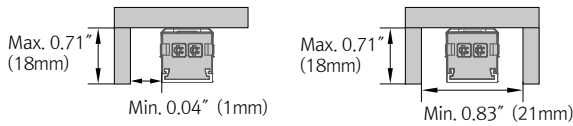
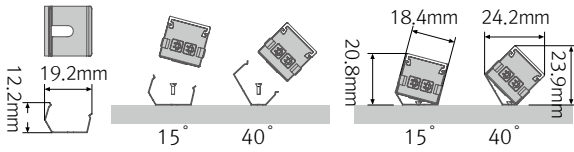
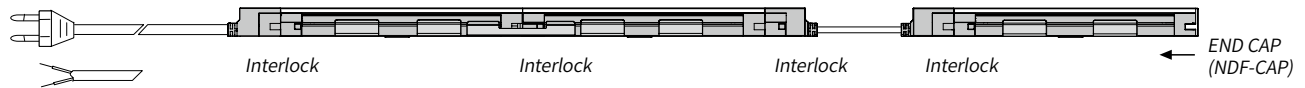

* When you disconnect NDF, please push the connector button and pull-out fixtures.

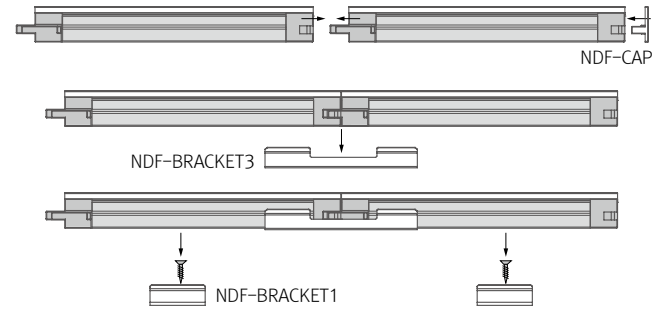

☆Pendant Installation

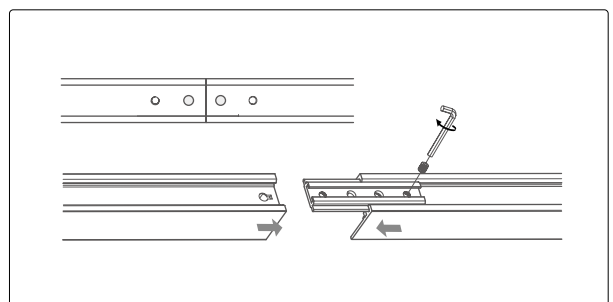
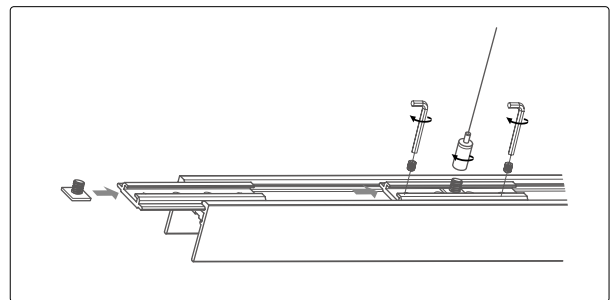
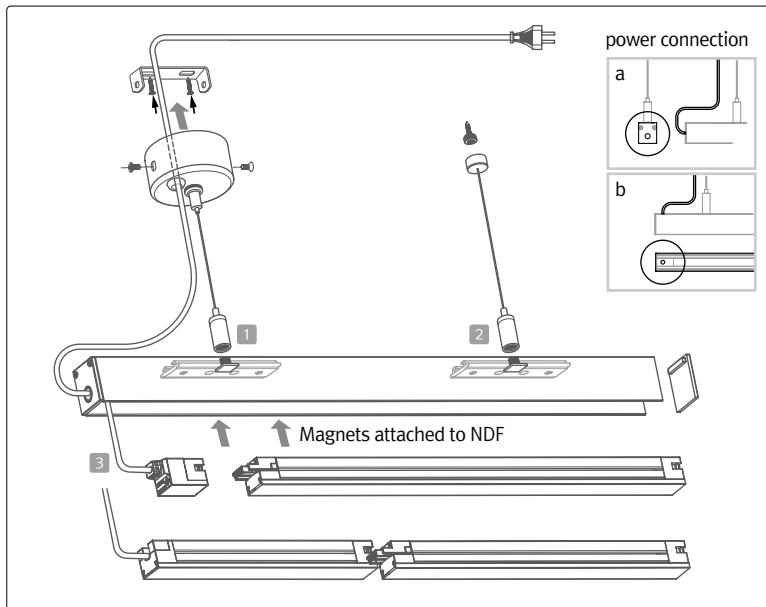

COMPONENTS

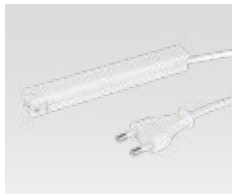

LED Power connector
 __NDF3-(Color)K-230V-PC
 NDF3 (5.8") fixture with
 6' power cord

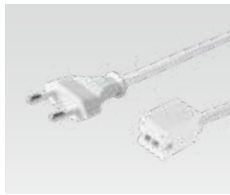

Power Cord
 __NDFPC/T (6')



Mounting Bracket
 __NDF-BRACKET1
 Included with fixture

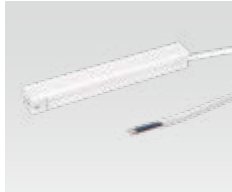

LED open power connector
 __NDF3-(Color)K-230V-OPC
 NDF3 (5.8") fixture with
 6' open power cord

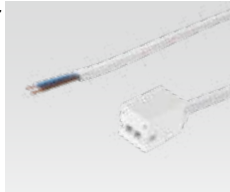

Open Power Cord
 __NDFOPC/T (6')



Angle bracket
 __NDF-BRACKET2



LED 90° Connector
 __NDF3-(Color)K-230V-90



Connecting Cable
 __NDFPTC/T (6")
 __NDFPTC1/T (1')
 __NDFPTC2/T (2')
 __NDFPTC4/T (4')
 __NDFPTC6/T (6')



Connecting bracket
 __NDF-BRACKET3
 Included with fixture



Flexible Connector
 __NDF3-(Color)K-230V-Flex2
 (14.15")
 __NDF3-(Color)K-230V-Flex3
 (20.53")
 __NDF3-(Color)K-230V-Flex5
 (32.7")



Extrusion End Cap
 __NDF-EXL-CAP
 Included with Track



Suspension bracket
 __NDF-SK-BRACKET
 Suspension Bracket for NDF



On/Off Switch
 __NDF-SW



NDF Extrusion line
 __NDF-EXL (1.2m)
 __NDF-EXL (2.4m)



Suspension Power Kit
 __NDF-SK-POWER
 Suspension Power Kit
 for NDF



**90 degree connector for
 NDF-EXL**
 __NDF-EXL-90



Extrusion Joint Bracket
 __NDF-JOINT BRACKET



**Dimming Interface
 (Bluetooth)**
 __FDS-H1B-SR
 Max. 200W (100W/CH,1CH)



**Dimming Interface
 (Dail)**
 __FDS-H1DA-SR
 Max. 200W (200W/CH,1CH)



**Dimming Interface
 (Dail)**
 __FDS-H2DA-SR
 Max. 288W (144W/CH,2CH)